



IMPRESSA X90/X95

Instructions for use



I
M
P
R
E
S
S
A

Legend:

- **DISPLAY** DISPLAY: serves as information.
- **DISPLAY** **DISPLAY**: please follow the instructions shown.

 = Note

 = Important

 = Tip



Fig. 1



Fig. 2



Fig. 3



Fig. 4



Fig. 6

Fig. 5



Fig. 7

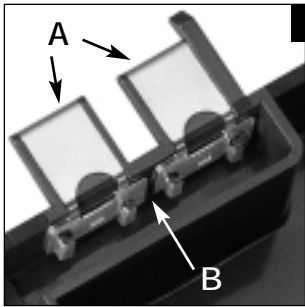

Fig. 8



Fig. 9

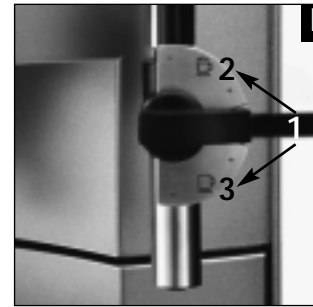
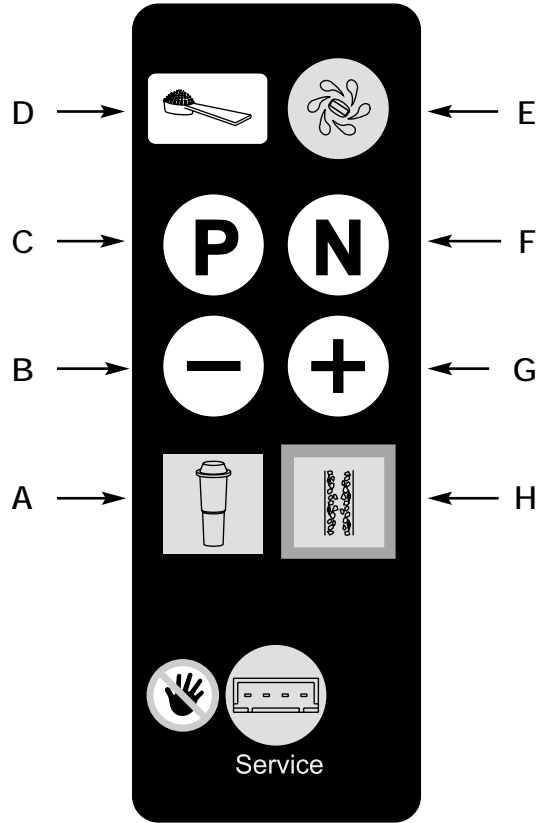
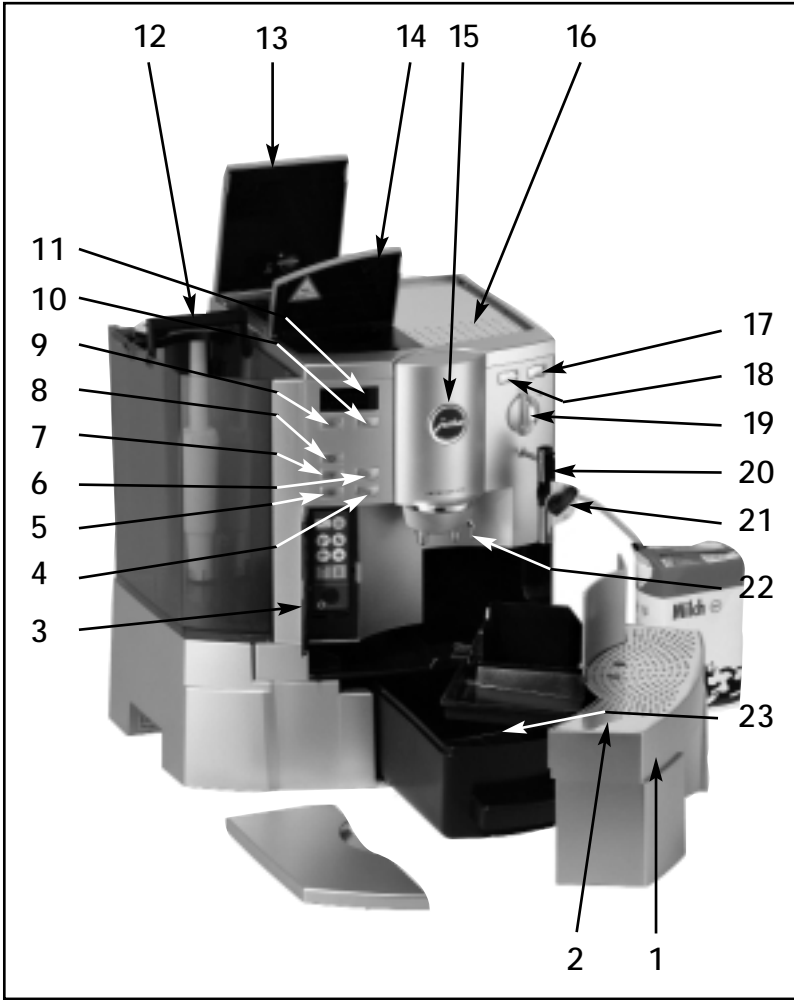

Fig. 10



Instructions for use

- 1 Drip tray / residual water container
- 2 Drip tray cover
- 3 Cover for programming keys
- 4 Coffee key for 2 large cups
- 5 Coffee key for 1 large cup
- 6 Coffee key for 2 small cups
- 7 Coffee key for 1 small cup
- 8 Key for special coffee
- 9 ON/OFF switch
- 10 Rinsing key
- 11 Display dialogue system
- 12 Water tank with carrying handle
- 13 Cover for bean container and aroma protection lid
- 14 Cover for pre-ground coffee filler funnel
- 15 Height-adjustable coffee-spout
- 16 Cup warming tray
- 17 Selector key for steam
- 18 Selector key for steam portion
- 19 Selector switch for coffee or hot water
- 20 Pivoting nozzle for steam
21. Profi Auto-Cappuccino/Caffè Latte
- 22 Height-adjustable tea-spout
- 23 Container for coffee grounds

Programming keys

- A Change filter
- B Back-setting of criteria / changing of memory indications downwards
- C Open program
- D Selector switch for pre-ground coffee
- E Key for cleaning program
- F Correction of program / close
- G Forward-setting of criteria / changing of memory indications upwards
- H Key for decalcifying program

Table of contents

1. Description	page 7	13.1 Programming powder quantity	page 13
2. Safety instructions	page 7	13.2 Programming coffee temperature	page 13
2.1 Warnings	page 7	13.3 Programming water quantity	page 13
2.2 Safety precautions	page 7	13.4 Programming steam portion	page 13
3. Check before use	page 8	13.5 Programming tea portion	page 14
3.1 Checking mains voltage	page 8	13.6 Programming filter	page 14
3.2 Checking fuse	page 8	13.7 Programming water hardness	page 14
3.3 Adding coffee beans	page 8	13.8 Programming economy mode	page 14
3.4 Adjusting grinder	page 8	13.9 Programming timer clock	page 14
4. Preparing machine	page 8	13.10 Programming automatic switch on time	page 15
4.1 Fill system with water	page 8	13.11 Programming automatic switch off time	page 15
4.2 Cup illumination	page 8	13.12 Cup counter	page 15
5. Rinsing the machine	page 9	13.13 Programming language selection	page 15
6. Adjusting for water hardness	page 9	13.14 Program key 	page 15
7. Use of Claris filter cartridges	page 9	14. Care and maintenance	page 16
7.1 Placing filter	page 9	14.1 Fill water	page 16
7.2 Replacing of filter	page 10	14.2 Empty grounds container	page 16
8. Drawing off coffee	page 10	14.3 Empty drip tray	page 16
8.1 Drawing off powder coffee	page 11	14.4 Fill beans	page 16
9. Drawing off hot water	page 11	14.5 Removing foreign objects	page 16
10. Drawing off steam	page 11	14.6 Clean machine	page 16
11. Frothing up milk with the		14.7 Unit calcified	page 17
Profi Auto-Cappuccino/Caffè Latte	page 11	14.8 Cleaning metal contacts	page 17
11.1 Frothing up a portion of milk	page 11	14.9 General cleaning instructions	page 17
11.2 Constant frothing up of milk	page 12	14.10 Regular servicing	page 17
11.3 Drawing off hot milk using the		14.11 Empty system	page 17
Profi Auto-Cappuccino/Caffè Latte	page 12	15. Cleaning	page 17
11.4 Drawing off cappuccino using the		16. Decalcifying	page 18
Profi Auto-Cappuccino/Caffè Latte	page 12	17. Disposal	page 19
11.5 Controlling the temperature using the		18. Tips for a perfect coffee	page 19
Profi Auto-Cappuccino/Caffè Latte	page 12	19. Messages	page 20
11.6 Cleaning of the		20. Problems	page 21
Profi Auto-Cappuccino/Caffè Latte	page 12	21. Legal information	page 22
12. Switching off machine	page 12	22. Technical specifications	page 22
13. Programming	page 12		

Important information for the user

Thank you for choosing this Jura product.

Please study these instructions carefully before using your new machine and keep them in a safe place for easy reference in the future.

Should you require further information or should particular problems occur that are not dealt with in these operating instructions in sufficient detail for you, then please ask your local dealer for the information you require or contact Jura Elektroapparate AG directly.

1. Description

This fully-automatic espresso/coffee machine impresses because of its user-friendly operational mode and its ingenious technology. In just one brewing-process it can prepare 1 or 2 cups of excellent, professional-quality espresso/coffee with guaranteed froth. Been refined and further developed by Jura, the Intelligent Pre Brew Aroma System (I.P.B.A.S .,) ensures full coffee aroma.

The Auto-Cappuccino, for example, automatically takes charge of frothing the milk perfectly for your cappuccino. It sucks milk from a Tetra Pak or a jug, heats and froths it up. Just choose the programmable steam quantity or the continuous steam function. Preparing a cup of tea with your machine is as simple as can be as well. The water quantity can be programmed and you can put your teacup under the coffee-spout. Now the selected water quantity flows into your cup through a separate spout.

The machine works fully-automatically at the press of a key. A decoded text-display shows messages and simplifies the operation considerably. Because of the integrated rinsing, cleaning and decalcifying programs care and maintenance is quick and easy.

2. Safety instructions

2.1 Warnings

- Children are unaware of the dangers that electrical machines represent. Therefore children should never be left unsupervised around electrical machines.
- This machine should only be used by people who have read and understood the operating instructions.
- Never use a faulty machine or one with a damaged power cable.
- Never immerse the machine in water.

2.2 Safety precautions

- Never expose the machine to the effects of rain, snow or frost and never operate it with wet hands.
- Place your machine on a solid level surface. Never leave it on a surface that is warm or hot (hob etc.). Choose a location that is inaccessible for children or pets.
- Remove plug from power socket if an absence for a longer period of time (holidays etc.) is planned.
- Always remove plug from power socket before cleaning.
- When removing plug from power socket, never tug on the cord or on the machine itself.
- Never repair or open the machine yourself. All repairs should be performed by authorised service centres only using original Jura spare parts and accessories.
- The machine is connected to the mains power socket via an electric cable. Ensure that no-one trips over this cable and pulls down the machine. Keep children and animals at a distance to the machine.
- Never put the machine or even parts of it in the dishwasher.
- To prevent overheating place the machine in an airy place.

- If using acidic decalcifying agents be sure to immediately remove any splashes and drops from delicate surfaces, especially natural stone and wooden surfaces, or take corresponding precautions.

3. Check before use

3.1 Checking mains voltage

The machine is set for the correct voltage before leaving our factory. Ensure that your mains voltage corresponds to the details quoted on the rating plate attached to the bottom of the machine.

3.2 Checking fuse

The machine is designed for a current of 10 amps. Check that an appropriate fuse is fitted.

3.3 Adding coffee beans

- Lift up cover of the bean container (13) and remove aroma protection lid.
- Clean out any dirt or foreign object from the bean container.
- Fill the grinder container (Fig. 1) with coffee beans, replace aroma protection lid and close the cover.

3.4 Adjusting grinder

You can adjust the grinder to the roast of your coffee. We recommend the following:

for a light roast → a finer adjustment
for a dark roast → a coarser adjustment

- Open the cover of the bean container (13).
- To adjust grinding turn selector switch (Fig. 1) to the desired position.

- You have the following possibilities:
the smaller the dots, the finer the grinding
the bigger the dots, the coarser the grinding



The grinding grade should only be adjusted while the grinder is working.

4. Preparing machine

4.1 Fill system with water

- Switch your machine on by pressing ON/OFF key . The machine adjusts fully-automatically to the starting position.
- **DISPLAY** PLEASE WAIT
- **DISPLAY** FILL SYSTEM / PRESS STEAM
- Press key .
- **DISPLAY** FILL WATER
- Remove water tank and rinse well with clear tap-water.
- Fill water tank and replace. Make sure that tank engages well.
- **DISPLAY** FILL SYSTEM / PRESS STEAM
- Place a container under the pivoting nozzle (20) and press key .
- **DISPLAY** PLEASE WAIT
- **DISPLAY** RINSE UNIT
- Place a container under the coffee-spout (15) and press rinsing key .
- **DISPLAY** UNIT RINSING
- **DISPLAY** COFFEE READY

4.2 Cup illumination

The cup illumination puts your coffee in a good light, making it a treat for the eyes.

When you switch on the machine or press any key, the cup illumination is activated for 3 minutes. To switch on the cup illumination, with the machine switched off, press any key.

5. Rinsing the machine

■ **DISPLAY** RINSE UNIT

- Place an empty cup under the coffee-spout (15).
- Press rinsing key .



If the machine has been switched off and has already cooled down it will be necessary to carry out this rinsing function when the machine is switched on again. After switching off the machine, the rinsing sets off automatically.

6. Adjusting for water hardness

The water is heated inside the machine. With use, this leads to calcium deposits (furring) forming on the machine. This will be automatically indicated on the display.

For this reason, it is necessary to adjust the machine to the hardness of your local water before you use it for the first time. Use the enclosed test-sticks for this purpose.



1° water hardness on the German scale represents 1.79° on the French scale.

The machine has got 5 hardness settings to choose from. While adjusting, the chosen grade is shown on the display.

The symbols on the display mean:

HARDNESS

LEVEL—: water hardness function is switched off

HARDNESS German water hardness 1 – 7°

LEVEL 1: French water hardness 1.79 – 12.53°

HARDNESS German water hardness 8 – 15°

LEVEL 2: French water hardness 14.32 – 26.85°

HARDNESS German water hardness 16 – 23°
LEVEL 3: French water hardness 28.64 – 41.14°
HARDNESS German water hardness 24 – 30°
LEVEL 4: French water hardness 42.96 – 53.7°

The machine is adjusted to hardness level 3 before it leaves the factory. You can alter this setting by following the instructions below:

- Switch the machine on by pressing ON/OFF key . The machine adjusts fully-automatically to the starting position.

■ **DISPLAY** PLEASE WAIT



- Open cover (3) and press key , until you hear an acoustic signal.

■ **DISPLAY** PRESS KEY / POWDER QUANTITY

- Press key  several times until the following message appears:

■ **DISPLAY** HARDNESS LEVEL 3

- By pressing key  you can hear an acoustic signal, the set hardness level flashes.

- You can alter the hardness level by pressing key  or . After setting, press key  once again to confirm. An acoustic signal can be heard.

- Press key  to return to stand-by-status.



7. Use of Claris filter cartridges



Under proper implementation of Claris filter cartridges, decalcifying of the machine becomes unnecessary. For further information, please read the brochure “Claris. Tough to calcium deposits, gentle to your coffee machine“.

7.1 Placing filter

- Pull up cartridge mounting. Pressing lightly, place the filter cartridge in the water tank (Fig. 2).

- Pull down cartridge mounting, until it engages audibly.
- Fill water tank with cold, fresh tap-water and replace it.
- Switch the machine on by pressing key  ON/OFF.
- Open front cover (3) and press key  until you hear an acoustic signal.



■ **DISPLAY PRESS KEY / POWDER QUANTITY**

- Press key  several times until the following message appears:

■ **DISPLAY FILTER NO**

- By pressing key  you can hear an acoustic signal.

■ **DISPLAY NO flashes**

- You can alter the setting by pressing key  or .

■ **DISPLAY YES flashes**

- To confirm press key . An acoustic signal can be heard.

■ **DISPLAY RINSE FILTER / PRESS STEAM**

- Place a sufficiently large container (approx. 1 litre) under the pivoting nozzle (20) and press coffee key .

- **DISPLAY PLEASE WAIT / FILTER RINSING.** The drawing off of water will stop automatically.

■ **DISPLAY FILTER YES**

- Press key .

■ **DISPLAY COFFEE READY**

- ➡ The water might be slightly discoloured (this is not damaging to the health).

7.2 Replacing of filter

After drawing off 50 litres the filter loses its effect.

■ **DISPLAY REPLACE FILTER**

If only a little water is drawn off the filter should be changed every 2 months. However no message will appear on the display. You will find a special turntable on the cartridge mounting to set the replacement date.

- Empty water tank and pull up cartridge mounting. Pressing lightly, place the filter cartridge in the water tank (Fig. 2).

- Pull down cartridge mounting, until it engages audibly.

- Fill water tank with cold, fresh tap-water and replace it.

- Switch the machine on by pressing key ON/OFF .

- Open front cover (3) and press key , until you hear an acoustic signal.

■ **DISPLAY RINSE FILTER / PRESS STEAM**

- Place a sufficiently large container (approx. 1 litre) under the pivoting nozzle (20) and press coffee key .

■ **DISPLAY PLEASE WAIT / FILTER RINSING**

■ **DISPLAY COFFEE READY**

- ➡ The water might be slightly discoloured (this is not damaging to the health).

8. Drawing off coffee

- Switch the machine on by pressing key ON/OFF .

■ **DISPLAY PLEASE WAIT**

■ **DISPLAY RINSE UNIT**

Put an empty cup under the coffee-spout (15) and press rinsing key .

■ **DISPLAY UNIT RINSING**

■ **DISPLAY COFFEE READY**

- Put 1, respectively 2 cups under the coffee-spout and press the required key. The pre-brew system (I.P.B.A.S.®) moistens the coffee powder, briefly interrupts the flow and then starts the real brewing process.



- ➡ You can interrupt the flow of coffee at any time by simply pressing any of the coffee keys.

- 💡 To obtain a perfect layer of froth adjust the coffee-spout (Fig. 3) to the size of your cups.



8.1 Drawing off powder coffee



- Open cover (3)
- Press selector key for pre-ground powder coffee .
- **DISPLAY FILL POWDER**
- Now put 1 or 2 level measuring spoons of pre-ground coffee into the pre-ground powder funnel (14).
- Put 1, respectively 2 cups under the coffee-spout (15) and press the required key.

 Never use soluble instant coffee or quick coffee. Only use coffee powder from freshly ground beans or pre-ground vacuum-packed coffee. **Never fill the funnel with more than 2 portions coffee powder at a time. The powder funnel is not intended as a storage container.**

 If selector key  is pressed by mistake this can be corrected by pressing one of the coffee keys. The rinsing program is then activated.

9. Drawing off hot water

- Put a cup under the height-adjustable coffee spout (22) and turn selector switch for hot water (19) to the symbol . The machine will now deliver hot water.
- **DISPLAY TEA PORTION**
- The drawing off of hot water will stop automatically.
- **DISPLAY CLOSE TAP**
- Turn selector switch for hot water back to the symbol .

 To stop this process turn selector switch for hot water (19) back to the symbol .





10. Drawing off steam

Steam can be used for heating liquids. Make sure that the steam/frothing nozzle (Fig. 4) is pushed upwards when liquids are heated. Push down the frothing aid to froth liquids.

 In the case of machine types, the steam / frothing aid is installed as a standard (Fig. 4)



 You can install the Profi Auto-Cappuccino/Caffè Latte. This is included in the Welcome Pack (also refer to Chapters 11.3/11.4/11.5).

11. Frothing up milk with the Profi Auto-Cappuccino/Caffè Latte



Your machine is ready for frothing up milk as soon as both selector key warning lamps   glow constantly. If the lamps do not glow, then press either steam-key  .

11.1 Frothing up a portion of milk

- Pour milk into a milk container and immerse the intake-tube in the milk.
- Put a cup under the pivoting nozzle (20) and press key .
- **DISPLAY STEAM PORTION**
- The drawing off of steam will stop automatically
- **DISPLAY COFFEE READY**

 If the Profi Auto-Cappuccino/Caffè Latte has not been used for a longer period of time, press selector key  first, until the milk is taken in, then selector key . In this way you will obtain a regular steam portion.

11.2 Constant frothing up of milk

- Pour milk into a milk container and immerse the intake-tube in the milk.
- Put a cup under the pivoting nozzle (20) and press key . Your milk froths up.
- **DISPLAY** STEAM INTAKE
- When the required amount of froth has been attained push selector key  anew.
- **DISPLAY** COFFEE READY

11.3 Drawing off hot milk using the Profi Auto-Cappuccino/Caffè Latte

The Profi Auto-Cappuccino/Caffè Latte can be used to draw off hot milk. Adjust the selector lever (1) (Fig. 10) to position (3) to draw off hot milk.

 Install the Profi Auto-Cappuccino/Caffè Latte. This is included in your Welcome Pack.

11.4 Drawing off cappuccino using the Profi Auto-Cappuccino/Caffè Latte

The Profi Auto-Cappuccino/Caffè Latte can be used to draw off cappuccino. Adjust the selector lever (1) (Fig. 10) to position (2) to draw off cappuccino.

11.5 Controlling the temperature using the Profi Auto-Cappuccino/Caffè Latte

Adjust the selector lever (1) to **+** for hot milk/cappuccino or **-** for less hot milk/cappuccino. Individual fine adjustment is possible.

11.6 Cleaning the Profi Auto-Cappuccino/Caffè Latte

As soon as you have frothed enough milk, it is important to clean the Profi Auto-Cappuccino/Caffè Latte.

Fill water in a milk container and immerse the intake-tube in the water. Now draw off steam until the water/steam mixture flowing into your cup is completely clean. Your Profi Auto-Cappuccino/Caffè Latte is clean again.

 Remove Profi Auto-Cappuccino/Caffè Latte (21). If you do not achieve optimum results, disassemble the flow controller and the selector lever (Fig. 10). Thoroughly rinse these parts with water.

12. Switching off machine

When the machine is switched off, the rinsing program is automatically run again. Therefore place an empty container under the coffee-spout (15) and press ON/OFF key . When the rinsing water has run into the container, the machine powers down. Discard the water.

13. Programming

Before leaving our factory, the machine is adjusted to enable you to obtain coffee without any additional programming. In order to adapt the result to your personal taste, various settings can be programmed individually. The programming keys are located behind the front cover (3).

The following settings can be programmed:

- ▶ Powder quantity
- ▶ Coffee temperature
- ▶ Water quantity
- ▶ Steam portion
- ▶ Tea portion

- ▶ Filter
- ▶ Water hardness
- ▶ Economy mode
- ▶ Timer clock
- ▶ Automatic switch on time
- ▶ Automatic switch off time
- ▶ Supplies and cup counter
- ▶ Language selection

13.1 Programming powder quantity

- Switch the machine on by pressing ON/OFF key **⏻**.
- Press key **Ⓟ** until you can hear an acoustic signal.
- **DISPLAY** POWDER QUANTITY / SELECT KEY
- Now press the key that you want to programme. Use the key for 1 cup only. The corresponding quantity for 2 cups is adjusted automatically by the machine after programming is finished.
- **DISPLAY** **POWDER**
⊖ **II** **⊕**
- The powder quantity can be selected by pressing keys **⊕** or **⊖** briefly.
- To store the new powder quantity in memory briefly press key **Ⓟ**.
- **DISPLAY** POWDER QUANTITY / SELECT KEY.
- By pressing the **⊕** button, you can select the next phase, or press the **Ⓝ** button in order to leave the programming.

13.2 Programming coffee temperature

- **DISPLAY** TEMPERATURE COFFEE / SELECT KEY
- Now press the key that you want to programme.
- Select the required temperature (high or normal) by activating key **⊕** or **⊖**.
- To store the new coffee temperature in memory briefly press key **Ⓟ**.

- **DISPLAY** TEMPERATURE COFFEE / SELECT KEY
- By pressing the **⊕** button, you can select the next phase, or press the **Ⓝ** button in order to leave the programming.

13.3 Programming water quantity

- **DISPLAY** WATER QUANTITY / SELECT KEY
- Put a cup under the coffee-spout (15) and then press the key that you want to programme.
- **DISPLAY** The selected value is confirmed
- Now your machine prepares a coffee.
- **DISPLAY** **ENOUGH COFFEE? / PRESS KEY** **Ⓟ**
- **DISPLAY** **OK?** **Ⓟ** **⊖** **II** **⊕**
- When the required water quantity is reached press key **Ⓟ**. You can call up the next setting by pressing key **⊕**.
- There is an additional possibility to alter the water quantity anew. Press key **⊕** or **⊖** for this purpose.
- If you wish to draw another coffee to control the water quantity, press key again otherwise press key **Ⓟ** briefly to store water quantity in memory.
- By pressing the **⊕** button, you can select the next phase, or press the **Ⓝ** button in order to leave the programming.

13.4 Programming steam portion

- **DISPLAY** STEAM PORTION
- Press key **Ⓟ**.
- **DISPLAY** PORTION /...20 SEC.
- By pressing key **⊕** or **⊖** you can programme time in seconds (drawing off time of 3 – 250 sec.)
- Press key **Ⓟ**.
- **DISPLAY** STEAM PORTION

- By pressing the ⊕ button, you can select the next phase, or press the ⊞ button in order to leave the programming.

13.5 Programming tea portion

- Place a cup under the height-adjustable tea-spout (22).
- Press key ⊕.
- **DISPLAY OPEN TAP**
- **DISPLAY ENOUGH TEA? / CLOSE TAP**
- **DISPLAY TEA PORTION**
- The required portion of tea-water is programmed now.
- By pressing the ⊕ button, you can select the next phase, or press the ⊞ button in order to leave the programming.

13.6 Programming Filter

Please read chapter 7.1 “Placing filter“.

13.7 Programming water hardness (only with setting Filter no)

- **DISPLAY HARDNESS LEVEL 3**
- Press key ⊕.
- By pressing key ⊕ or ⊖ briefly you can programme the water hardness level.
- Then press key ⊕ briefly to store the water hardness level in memory.
- By pressing the ⊕ button, you can select the next phase, or press the ⊞ button in order to leave the programming.

 To determine the water hardness level please read chapter 6. “Adjusting for water hardness“.

13.8 Programming economy mode

- **DISPLAY ECONOMY MODE OFF**
- Press key ⊕.
- By briefly pressing key ⊕ or ⊖ you can programme the mode you would like.
- Then press key ⊕ briefly to store mode in memory
- By pressing the ⊕ button, you can select the next phase, or press the ⊞ button in order to leave the programming.

You can programme your machine to “economy mode“. In the setting ECONOMY MODE ON the steam heating-system is switched off. The heating for the cup warming tray is switched off too. If you want to draw off steam you need to press the steam key ⏏, warning lamps flash and your machine heats up.

 After 10 minutes the steam heating-system switches off automatically. The warning lamps go out. By pressing the steam key anew, you return to stand-by-status for drawing off steam.

ECONOMY MODE OFF means that the stand-by-status for steam is set to 20 minutes and the heating for the cup warming tray is on. After 10 minutes the warning lamp goes out. By pressing the steam key anew, the machine returns to stand-by-status for drawing off steam.

13.9 Programming timer clock

 A programming of the timer clock is necessary if an automatic switch on time is required.

- **DISPLAY TIME —.—**
- Press key ⊕.
- By briefly pressing key ⊕ or ⊖ you can set the hours and then confirm by pressing key ⊕.

- By briefly pressing key \oplus or \ominus you can set the minutes and then confirm by pressing key \textcircled{P} .
- By pressing the \oplus button, you can select the next phase, or press the \textcircled{N} button in order to leave the programming.

13.10 Programming automatic switch on time

A programming of the timer clock is necessary if an automatic switch on is needed.

- **DISPLAY** UNIT ON —.—
- Press key \textcircled{P} .
- By briefly pressing key \oplus or \ominus you can set the hours and then confirm by pressing key \textcircled{P} .
- By briefly pressing key \oplus or \ominus you can set the minutes and then confirm by pressing key \textcircled{P} .
- By pressing the \oplus button, you can select the next phase, or press the \textcircled{N} button in order to leave the programming.

- ➔ To switch off the automatic timer proceed as follows:
Press key \textcircled{P}
Press key \textcircled{N}
DISPLAY UNIT ON —:—

13.11 Programming automatic switch off time

- **DISPLAY** OFF AFTER 5.0 HOURS
- Press key \textcircled{P}
- By briefly pressing key \oplus or \ominus you can set the hours and then confirm by pressing key \textcircled{P} (0.5 to 9.0 hours).
- By pressing the \oplus button, you can select the next phase, or press the \textcircled{N} button in order to leave the programming.

13.12 Cup counter

- **DISPLAY** 200 SUPPLIED (TOTAL SUPPLIED)
- To obtain the information press the required key. The display will show you the number of times the function has been chosen.
- By pressing the \oplus button, you can select the next phase, or press the \textcircled{N} button in order to leave the programming.

- ➔ It is not possible to call up hot water and steam supplies.

13.13 Programming language selection

- Press key \textcircled{P}
- By briefly pressing key \oplus or \ominus call up the language desired and then confirm by pressing key \textcircled{P} .
- By pressing the \oplus button, you can select the next phase, or press the \textcircled{N} button in order to leave the programming.

13.14 Program key \textcircled{N}

By using key \textcircled{N} you can set back the following settings (powder quantity, coffee temperature, water quantity, steam portion, tea portion) to their original standard settings.

- **DISPLAY** COFFEE READY
- Press key \textcircled{N} until you can hear an acoustic signal.

- ➔ If a mistake occurs while programming one of the above settings, just press key \textcircled{N} and the chosen setting moves back to its original standard setting.

14. Care and maintenance

14.1 Fill water

■ **DISPLAY FILL WATER**

- If this message shows on the display no more coffee can be drawn off. Top up water.



The water tank should be rinsed and filled with fresh water daily. Only use fresh, cold water. Never top up with milk, mineral water or any other liquids. You can top up water without removing tank.

14.2 Empty grounds container

Coffee grounds are collected in the grounds container (23).

■ **DISPLAY EMPTY GROUNDS**

- If this message shows on the display no more coffee can be drawn off. It is necessary to empty the grounds container.
- Remove drip tray carefully as there is water in it.



Do **not** disconnect the machine from power socket while you empty grounds.

14.3 Empty drip tray

■ **DISPLAY EMPTY TRAY**

- If this message shows on the display no more coffee can be drawn off. It is necessary to empty the drip tray.
- Remove drip tray carefully as there is water in it.

14.4 Fill beans

■ **DISPLAY FILL BEANS**

- Fill beans as described in chapter 3.3.



The message FILL BEANS will only disappear after drawing off a coffee. We recommend cleaning the bean container from time to time with a dry cloth before you refill beans. Switch off the machine for this purpose.

14.5 Removing foreign objects

- Switch off your machine by pressing ON/OFF key
- Remove plug from power socket.
- Open bean container (13) and remove the beans. The remaining beans can be removed with a vacuum cleaner.
- Loosen both screws in the bean container and then remove container (Fig.5 + 6)
- Remove any remaining beans with a vacuum cleaner.
- Put the spanner on (Fig.7).
- Now turn spanner anticlockwise until the foreign object loosens.
- Remove remaining powder with a vacuum cleaner.
- Replace bean container and fasten screws.

14.6 Clean machine

■ **DISPLAY CLEAN UNIT**

After coffee, etc., has been drawn off 220 times or after 180 rinsing programs have been run, the machine must be cleaned. You can continue to draw off coffee and hot water / steam. However we recommend that you clean the machine (as described in chapter 15) within the next few days.

■ **DISPLAY** CLEAN NOW

An acoustic signal indicates the need of an immediate cleaning.

14.7 Unit calcified

■ **DISPLAY** UNIT CALCED

The machine signals when decalcifying becomes necessary.

 Under the correct implementation of Claris filter cartridges, decalcifying of the machine becomes unnecessary. For further indications read Chapter 7 "Use of Claris filter cartridges".

14.8 Cleaning metal contacts

■ **DISPLAY** EMPTY TRAY / CLEAN CONTACTS

- The remnants of the calcified deposits in the area of the metal contacts must be removed. Proceed as follows:
- Rinse fastenings in groove (B) as well as the metal contacts (A) with hot water and some washing-up liquid. Then clean the fastenings in groove (B) as well with a brush (Fig. 8).

14.9 General cleaning instructions

- Never use abrasive articles or corrosive chemicals to clean your machine.
- Wipe down the casing inside and out using a soft, damp cloth.
- Clean the pivoting nozzle after every use.
- After warming milk, draw off some hot water to clean the pivoting nozzle inside.
- You can take off the Profi Auto-Cappuccino/Caffè Latte for a thorough cleaning.
- The water tank should be rinsed and filled with clean water daily.



If you notice any furring in the water tank, this can be decalcified separately with a customary decalcifying agent. Remove the tank from the machine for this purpose.



If a Claris filter cartridge is used, remove it beforehand.



14.10 Regular servicing

Regular Jura services ensure your machine's reliability and longer life. Keep the original packaging to protect the machine while being transported.

14.11 Empty system



This procedure is necessary to prevent your machine from frost damage while being transported.

- Put a container under the pivoting nozzle (20).
- Press selector key  and remove water tank
- **DISPLAY** STEAM INTAKE
- **DISPLAY** PRESS STEAM / FILL SYSTEM
- Switch off machine by pressing ON/OFF key .



15. Cleaning

The machine has an integrated cleaning program. The procedure lasts about 15 minutes.

Please use Jura cleaning tablets only. These are available from your Jura dealer.



It is essential not to interrupt the process once it has been started.

- Switch on your machine by pressing ON/OFF  key
- Press key  until you can hear an acoustic signal.
- **DISPLAY** EMPTY TRAY (FILL WATER might show as well)



Put a sufficiently large container under the coffee-spout (15) in order to prevent cleaning liquid from running into the drip tray.

- **DISPLAY** ADD TABLET (Fig. 9) / PRESS CLEANING
- **DISPLAY** UNIT CLEANING / PLEASE WAIT
- **DISPLAY** EMPTY TRAY
- **DISPLAY** PLEASE WAIT
- **DISPLAY** RINSE UNIT
- **DISPLAY** COFFEE READY



The powder funnel for pre-ground coffee should be cleaned after each cleaning process. Remove it from the machine, rinse it with hot tap water and replace it after drying.

16. Decalcifying

Your machine has an integrated decalcifying program. It lasts approx. 50 minutes.

Please use Jura decalcifying tablets only. These are available from your Jura dealer.





Run the decalcifying program only after the machine has been **switched off for at least 5 hours** and has cooled down completely. The running decalcifying program must **not** be interrupted.



If using acidic decalcifying agents be sure to immediately remove any splashes and drops from delicate surfaces, especially natural stone and wooden surfaces, or take corresponding precautions.

In any case please wait until the filled decalcifying agent is used up and the tank is empty. Never top up the decalcifying agent.



- Remove and empty water tank.
- Replace empty water tank.
- Switch off your machine by pressing ON/OFF  key and let it cool down for approx. 5 hours.
- Open cover (3).
- Press key  until you can hear an acoustic signal.
- **DISPLAY** EMPTY TRAY
- **DISPLAY** AGENT IN TANK

Pour 0.6 litres of water into a container and completely dissolve the contents of a blister pack (2 tablets). Then fill the mixture into the water tank.

- **DISPLAY** AGENT IN TANK / OPEN TAP / PRESS CALC



Place a sufficiently large container under the pivoting nozzle (20). Remove the Profi Auto-Cappuccino/Caffè Latte.

- Turn selector switch for coffee (19) to the symbol  and press key .
- **DISPLAY** UNIT DECALCIFYING / PLEASE WAIT
- When an acoustic signal is heard place a container under the height-adjustable tea-spout (22).
- **DISPLAY** PRESS CALC
- **DISPLAY** UNIT DECALCIFYING / PLEASE WAIT
- **DISPLAY** CLOSE TAP
- **DISPLAY** UNIT DECALCIFYING / PLEASE WAIT
- Inside the machine the decalcifying agent is conducted to the drip tray.
- **DISPLAY** EMPTY TRAY
- **DISPLAY** FILL WATER
- Place a container under the pivoting nozzle (20).
- **DISPLAY** OPEN TAP
- **DISPLAY** PRESS CALC

- **DISPLAY** UNIT DECALCIFYING / PLEASE WAIT
- Place a container under the height-adjustable tea-spout (22).
- **DISPLAY** **PRESS CALC**
- **DISPLAY** UNIT DECALCIFYING / PLEASE WAIT
- **DISPLAY** **CLOSE TAP**
- **DISPLAY** UNIT DECALCIFYING / PLEASE WAIT
- Inside the machine the water is conducted to the drip tray.
- **DISPLAY** **CLEAN CONTACTS / EMPTY TRAY**
(please refer to chapter 14.8)
- **DISPLAY** PLEASE WAIT
- **DISPLAY** **RINSE UNIT**
- **DISPLAY** UNIT RINSING
- **DISPLAY** COFFEE READY

17. Disposal

For correct disposal, you should return your coffee machine to your dealer, Jura service centre or Jura Elektroapparate AG.

18. Tips for a perfect coffee

Height adjustable coffee-spout

You can adjust the height of the coffee-spout to the size of your cups.

Grinding

Please refer to chapter 3.4 “Adjusting grinder”.

Pre-warm cups

You should warm cups in advance with hot water or steam. The smaller the quantity of coffee, the more important warming the cups is.

Sugar and cream

Warmth is lost by stirring the contents of the cup. Adding milk or cream from the refrigerator considerably lowers the temperature of the coffee.

19. Messages

DISPLAY	Cause	Action
FILL WATER	Water tank is empty Water level indicator in tank is jammed Tank is calcified, water level indicator is stuck	Top up with water Empty tank, rinse out, fill up and replace Remove tank, decalcify, rinse well, fill up with water and replace
FILL BEANS	Bean container is empty Message still displayed, although beans filled A foreign object is stuck in the grinder	Top up with beans Draw off cup of coffee. FILL BEANS message only disappears after coffee is drawn off Remove foreign object as described in chapter 14.5 “Removing foreign objects“
EMPTY GROUNDS	Coffee grounds container is full Message still displayed although grounds container emptied. The message appears after only a few cups have been drawn off	Remove drip tray, empty grounds container, replace tray The tray was out of the machine for less than 8 sec for emptying. Take tray out again for approx. 10 sec and replace Leave the machine switched on while the grounds container is being emptied. The counter is only reset to zero if the machine is left switched on
TRAY MISSING	Tray has not been replaced correctly Grounds have fallen under tray and are preventing it from being correctly inserted	Insert tray correctly Remove tray, clean inside of machine, replace tray
EMPTY TRAY	The residual water container is full Message still displayed, although container emptied	Remove container carefully, empty, rinse out and replace Remove container, clean metal contacts (please refer to chapter 14.8)

DISPLAY	Cause	Action
CLEAN UNIT	You have drawn off coffee 220 times or run the rinsing program 180 times Message still displayed, although machine cleaned	Clean as described in chapter 14.6 Run cleaning program again; this time do not add cleaning tablet
UNIT CALCED	The espresso/coffee machine sector needs decalcifying Message still displayed, although machine decalcified	Run decalcifying program as described in chapter 16 Run cleaning program again; this time using water only and without decalcifying agent
FAULT 2	Temperature too low	– Switch device off – Leave device for approx. 2 hours at room temperature – Switch device on
FAULT 8	Initialisation problem	Switch device off, disconnect from mains, switch on

20. Problems

Problem	Cause	Action
Coffee only flows in dribs and drabs while drawing off	– Powder too fine	– Adjust grinder to a coarser grinding – Run the rinsing programme once or twice. If the problem persists, run cleaning programme
Coffee flow is stopped after pre-brewing	– Not enough coffee powder in the system	– Draw off one cup of coffee
Grinder is extremely noisy	– Foreign element in grinder	– Proceed as described in chapter 14.5

Problem	Cause	Action
Not enough froth while frothing up milk	<ul style="list-style-type: none"> – Unsuitable milk-type – Frothing nozzle blocked – Clean Auto-Cappuccino 	<ul style="list-style-type: none"> – Use full cream milk – Clean frothing nozzle – Clean Profi Auto-Cappuccino/Caffè Latte as described in chapter 11.6

If the above mentioned problems and/or messages still persist, please contact your dealer or get in touch directly with Jura Elektroapparate AG.

21. Legal information

These operating instructions contain all the information necessary for the correct use, operation and maintenance of your espresso/ coffee machine.

Understanding and complying with the directions contained in these operating instructions are essential to ensure that the machine is utilised without risk and to ensure safety during operation and maintenance.

These operating instructions cannot cover all the possible ways in which this machine may be used.

We would like to further point out that the contents of these operating instructions in no way constitute a part of, or alter, any previous or existing contract, agreement or legal relationship. All obligations on the part of Jura Elektroapparate AG result solely from the relevant sales agreement which also contains full details of the only warranty terms valid in respect of this machine. The contractual terms of this warranty are neither extended nor limited in any form by the information in these operating instructions.

These operating instructions contain information that is protected by copyright. The photocopying or translation into any other language of these instructions without prior written authorisation from Jura Elektroapparate AG is strictly prohibited.

22. Technical specifications

Impressa X90/X95

Voltage:	230 V AC
Output:	1350 W
Fuse:	10 A
Safety check:	
Energy consumption standby:	approx. 4,4 Wh
Energy consumption ready to make coffee:	approx. 31 Wh, Economy Mode on approx. 41 Wh, Economy Mode off
Pump pressure:	max. 15 bar
Capacity, bean container:	280 gr.
Cable length:	approx. 1,1 m
Water tank:	5,7 litres
Capacity, grounds container:	max. 40 port.
Weight:	15 kg
Dimensions (B x H x D):	41 x 47 x 39 cm